

# GRACO®

## Tot Wheels Entertainer® Activity Center

### OWNER'S MANUAL

Model No. \_\_\_\_\_

Serial No. \_\_\_\_\_

Dear Customer,

Please fill in the model and serial numbers above from the label on the underside of the tray.

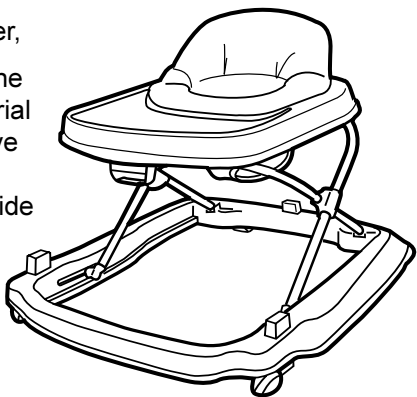

**Model 4033**

### Congratulations on your purchase of a Graco® Tot Wheels Entertainer® activity center!

Graco is the recognized leader in the design and manufacture of quality baby products. We believe your new Graco® Tot Wheels Entertainer® activity center is a wise choice, promising many hours of enjoyment for your baby.

Before using your activity center, please take a few minutes to read this Owner's Manual. The short time you spend reading these instructions will help you use your activity center properly.

### Customer Satisfaction

Our goal is to make every product the best it can be! We are also committed to supporting our products after purchase. If you would like to speak with us about your product, please contact our **Customer Service Department at 1-800-345-4109** or visit our Internet website, [www.gracobaby.com](http://www.gracobaby.com). Our knowledgeable staff will be ready to answer any questions you may have concerning parts, use or maintenance. When you call, please have the **model and serial numbers** ready so your call may be processed quickly and efficiently.

**WARNING**

Le

Graco is concerned about the safety of every child who uses one of our products. We are equally concerned about the safety of their children. There are certain things you can do to help minimize the risk that a baby using one of our mobile activity centers. The person in charge of the baby should always follow these rules.

### 1. Never leave your baby unattended.

Most accidents happen to children while they are unsupervised. At all times, you must keep the baby under a watchful eye. Because your baby is curious and eager to explore all sorts of potential hazards, direct attention to the baby at all times. If you believe proper supervision of your baby cannot be guaranteed, do not use the activity center, which the baby cannot be adequately protected while using our mobile activity center, and that you consider instead an activity center without wheels, swing or stroller.

### 2. Properly prepare your baby's play space.

Potential hazards in the room must be removed or guarded against before the baby is allowed to use the activity center. Remember that the mobile activity center gives the baby the ability to move around. Hazards that otherwise be possible. That means it's important to prepare play space by removing or guarding against reach, and closing doors to keep the baby away from potential hazards.

- Stairs
- Steps
- Raised thresholds
- Driveways and sidewalks
- Ramps or inclines
- Decks
- Ranges, heaters, fireplaces, hot liquids and other heat sources
- Blind corners
- Objects
- Dangling items
- Potted plants
- Books
- Bathtubs
- Swimming pools
- Any other hazards

Only your commitment to safety can give your baby the best.

### When to use your Tot Wheels Entertainer

- Your baby should be able to sit unaided and be able to support most of his/her body weight with his/her legs (about 6 months old).
- Both feet should be able to touch the floor.
- When your baby is able to play independently.
- When your baby is able to walk unaided.

### When NOT to use your Tot Wheels Entertainer

- Do not use until your child can sit up alone.
- When your child can walk unaided.
- When your child reaches 30 lbs. in weight.
- When your child has grown over 32 inches in height.
- If your activity center has become broken or damaged.
- If you haven't prepared a safe play space for your baby.
- If the child is not able to sit up alone.
- If the child is not able to walk unaided.
- If the child is not able to play independently.
- If the child is not able to walk unaided.

### Other things to avoid

- Don't lift or carry your baby in the activity center.
- Don't adjust the activity center with your baby in it.
- Don't use the activity center if it is broken or damaged.
- Don't use the activity center if it is broken or damaged.
- Don't use the activity center if it is broken or damaged.
- Don't use the activity center if it is broken or damaged.

Graco® activity centers have been designed with your child's enjoyment in mind. By following these guidelines and using simple common sense. Let's work together to keep your baby safe and happy.

# Let's play safe.

ne of our products. We know that parents and other caregivers are certain safety precautions which you must always take to vity centers will be harmed. Specifically, the parent or caregiver in

l.

d. At a minimum, the caregiver should be in the same room with ecause a baby can propel a mobile activity center at surprising ect and diligent supervision by the caregiver is required at all e guaranteed, or that your home presents particular dangers from r mobile activity center, we suggest that you not use this product , swing, playard, or other fine Graco® product for your baby.

## space — neutralize potential hazards.

ainst before placing a baby in a mobile activity center. Keep in o move around the play area much more quickly than would ay space by installing and using gates, removing objects from hazards, such as:

- Blind or drape cords
- Objects on tables
- Dangling electrical cords or small appliances
- Pots and pans on stoves
- Books on shelves
- Bathtubs or open toilets
- Swimming pools or other containers filled with liquid
- Any other dangers unique to your environment

our child the safe, happy playtime you desire.

## ainer® activity center

- When you are able to watch your baby at all times while playing in the activity center.
- When you have prepared your baby's play space according to these guidelines.

## ntertainer® activity center

- If the tray of your activity center is lower than your baby's waist level when your child stands in the activity center.
- If you haven't blocked access to stairs and steps.
- If you haven't assembled the activity center according to these instructions.

- Don't use the activity center with your child in it on a table or countertop.
- Keep dangling electrical cords out of baby's reach, such as an iron on an ironing board, lamp cords, etc.

oyment in mind. It is your responsibility to ensure your baby's safety et's work together to keep your baby safe and happy.

**⚠ WARNING**

## STAIR HAZARD:

Avoid serious injury or death. Block stairs/steps securely before using walker.



Avoid falls and other hazards. Never allow walker to be pushed while child is in it.

Never leave child unattended. Always keep child in view while in walker.

Use only on flat surfaces free of objects that could cause the walker to tip over.

To avoid burns, keep your child away from hot liquids, ranges, radiators, space heaters, fireplaces, etc.

To reduce the chance of your child slipping out of the seat, check that both of your child's feet touch the floor.

Never carry the product with the child in it.

Discontinue using the walker should it become damaged or broken.

Read all instructions before assembly and use of this product.

Keep instructions for future use.

## PARTS LIST

CHECK that you have all the parts listed below BEFORE assembling your activity center.

If any parts are missing, call Customer Service at 1-800-345-4109 or visit our Internet website, [www.gracobaby.com](http://www.gracobaby.com).

THIS PRODUCT REQUIRES ADULT ASSEMBLY.

Tools required: Wrench or pliers, screwdriver

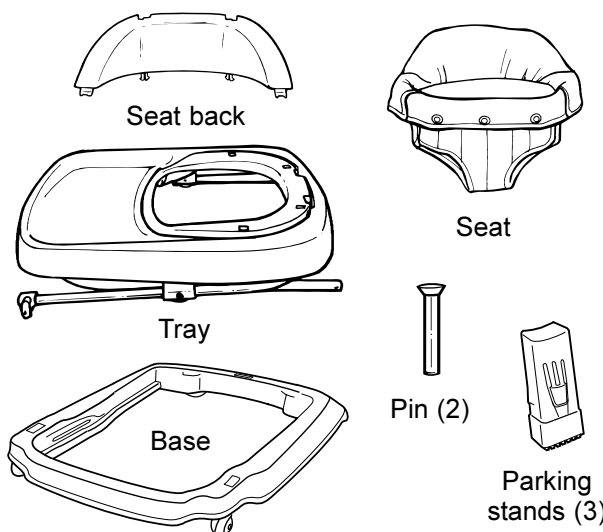

## To Assemble the Tray

### Step 1.

Insert front of seat back into two slots on top of tray as shown.

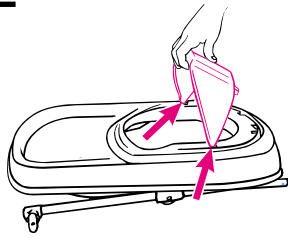

### Step 2.

Lower seat back so that fingers at rear of back snap into the two slots at rear of tray.

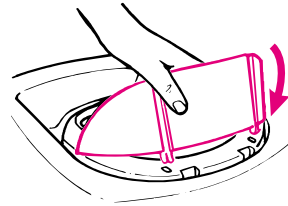

**CHECK that seat back is firmly attached by pulling upward on back. It should not come loose.**

## To Attach the Seat

### Step 1.

Place seat onto tray assembly as shown. Put "pocket" of seat over seat back, and place leg holes into center area of tray.

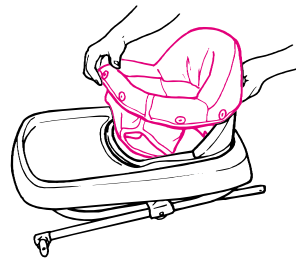

### Step 2.

Tuck edges of seat into channel in tray.

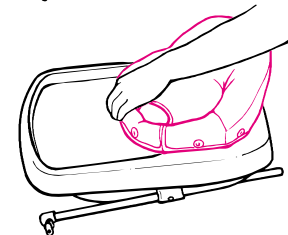

### Step 3.

From underside of tray, pull grommets through holes at bottom of tray and hook them onto pegs as shown. Be sure all eight grommets are hooked onto pegs.

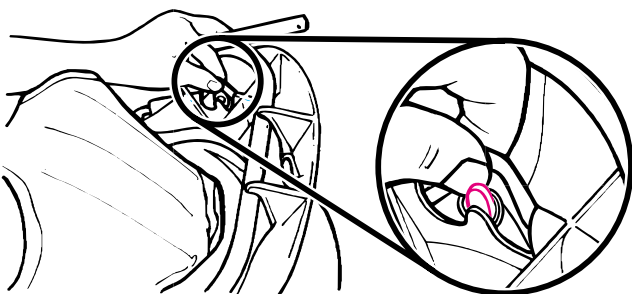

**Do not hook grommets on the flat tabs opposite the pegs.**

## To Attach the Base

### Step 1.

Place base on floor with wheels down.

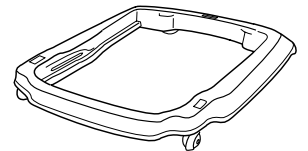

### Step 2.

Open tubes of tray assembly until they latch as shown.



### Step 3.

Front tube has plastic "T" ends. Tilt tray assembly as shown. Insert one plastic "T" into slot on the inside front of the base. Repeat on opposite side, flexing tube inward if needed to engage the slot.

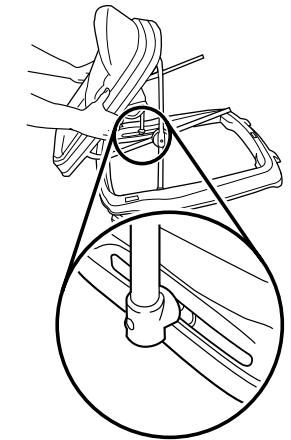

### Step 4.

Lower rear tube so holes in ends of tube line up with two holes in back of activity center base.

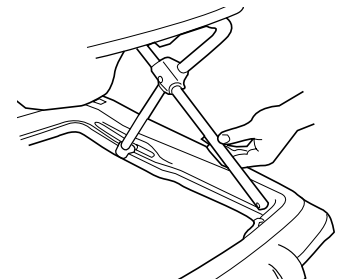

Be sure that plastic "T" pieces remain in their slots.

### Step 5.

Insert pin into hole on tab side of base hole, through tray tube, and out through base hole on the other side as shown. **Press firmly** until tab snaps over head of pin. Repeat on other side.

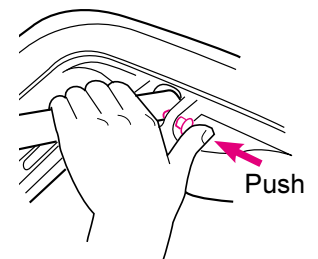

**Be sure all parts of tray and base are securely fastened, with "T" pieces in their slots and tabs holding pins firmly.**

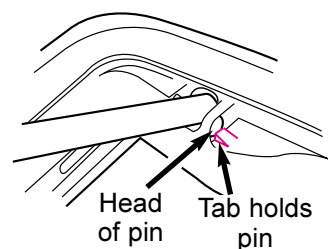

## To Attach the Decal

Place decal on front of the base as shown. **Rub over decal with hand or clean cloth to assure adhesion.**



## To Use Parking Stands

To install parking stands (two in the front, one in the back), lift base slightly, depress button on front of stands and push stands up until they snap into place.

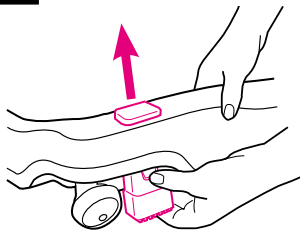

To use parking stands, lift base slightly and push stands down until they snap into place.

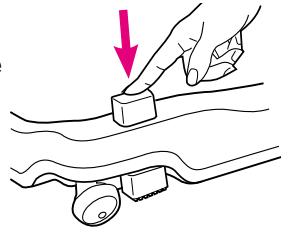

To release parking stands, lift base slightly and depress button on front of stands. Push stands upward into storage position.

## **⚠ WARNING**

- **When parking stands are in use, it is still possible for your child to move the activity center.**
- **Be sure to engage both parking stands.**
- **Never place the activity center on a table or countertop.**

## Friction Strip Feature

**⚠ WARNING** Avoid serious injury or death. **DO NOT** use product without the five friction strips under the base.

- Make sure strips are kept clean.
- Clean strips with **WATER ONLY**.

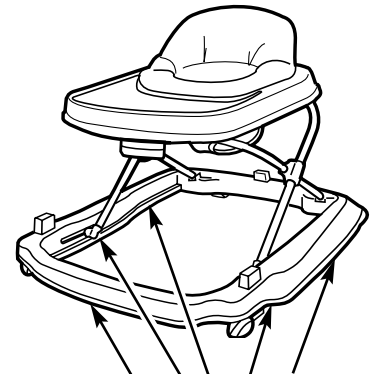

Friction strips under base

## To Adjust the Activity Center

**⚠ WARNING** Remove your child from the activity center before making any adjustments.

To raise or lower your activity center:

Push up button at front of tray as shown and **hold it**.

Push down or pull up while adjusting to desired height.

Tray should lower easily. **DO NOT** force tray down or unit could be damaged.

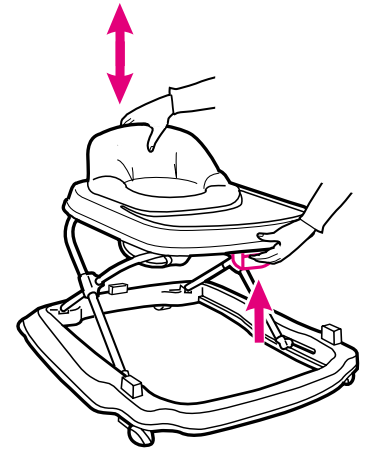

## To Attach the Spoiler

Line up the pegs on the bottom of the spoiler with the two holes at the back of the activity center and push the spoiler in until it snaps in place. It will not be removable.

**Do not** allow spoiler to block seat by inserting it backwards.

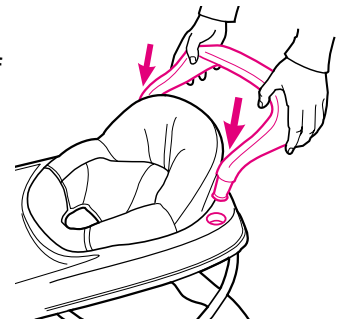

**⚠ WARNING** Avoid falls and other hazards. **Never** allow unit to be pushed while child is in product.

## To Assemble the Playtray

Before assembling, check that you have all the parts listed below:

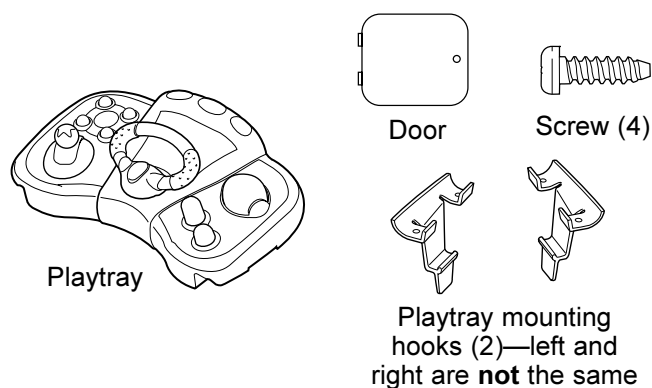

### Step 1.

With the playtray upside down, insert two AA batteries (we recommend alkaline disposables) into the bottom of the playtray following the molded directions for placement. **CHECK that the batteries are put in correctly. Your playtray will not function if the batteries are put in backwards.**

### Step 2.

To attach the battery compartment door, line up the tabs and set the door in place as shown.

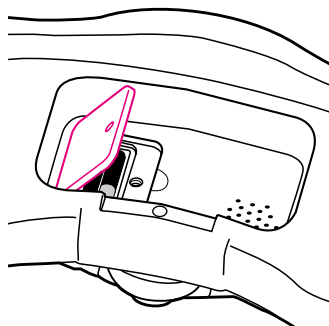

### Step 3.

Close the door and tighten the attached screw to hold door closed.

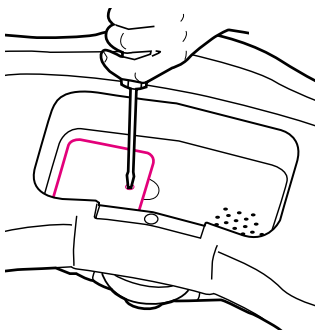

### Step 4.

Attach the right and left mounting hooks to the underside of the playtray with the four screws provided. The mounting hooks will only fit one way.

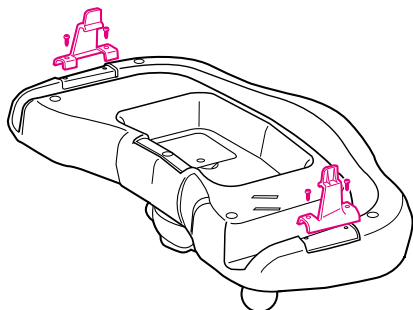

### Step 5.

Fasten the playtray to the activity center by placing it on the front of the tray as shown and snapping the two mounting hooks onto the activity center tray. **CHECK** that the playtray is securely fastened to the activity center tray.

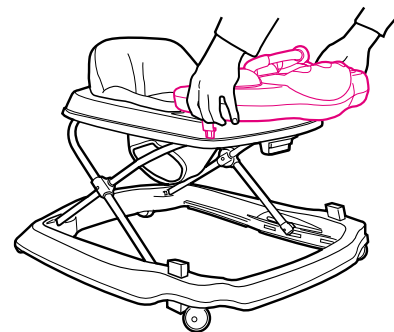

**▲ WARNING DO NOT lift this product by the playtray.**

### FOR SAFE BATTERY USE:

Keep the batteries out of children's reach.

Any battery may leak battery acid if mixed with a different battery type, if inserted incorrectly (put in backwards) or if all batteries are not replaced or recharged at the same time.

Any battery may leak battery acid or explode if disposed of in fire or an attempt is made to charge a battery not intended to be recharged. Never recharge a cell of one type in a recharger made for a cell of another type.

Discard leaky batteries immediately. Leaky batteries can cause skin burns or other personal injury. When discarding batteries, be sure to dispose of them in the proper manner, according to your state and local regulations.

Always remove batteries if the playtray is not going to be used for a month or more. Batteries left in the unit may leak and cause damage.

Recommended type batteries—alkaline disposables, size AA.

**NEVER** mix battery types.

Change batteries when playtray ceases to operate satisfactorily.

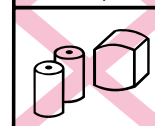

### Caring for the Activity Center

Make sure five friction strips under base are kept clean. Clean with water only.

To wash fabric seat, unhook the eight grommets under tray and lift seat off. Machine wash in lukewarm water on delicate setting and drip dry. **NO BLEACH.**

For cleaning metal and plastic parts other than friction strips, use only household soap or detergent and warm water. **NO BLEACH.**

Excessive exposure to sun or heat could cause fading or warping of parts.

# Replacement Parts

## Instructions for ordering activity center parts:

Complete form below. Your activity center model number **MUST** be included on the form to ensure proper replacement parts. **Your model number can be found on a sticker on the underside of the tray.**

**Payment must accompany your order.**

<b>Parts List:</b>	<b>Price:*</b>
Seat .....	\$13.00
Seat back .....	\$ 5.00
Caster .....	\$ 5.00 (each)
Rear wheel .....	\$ 8.00 (each)
Parking stand .....	\$ 5.00 (each)
Skid strip .....	\$ 5.00 (each)
Pin .....	No charge
Playtray .....	\$20.00
Mounting hooks (both) .....	\$ 5.00
Spoiler .....	\$ 7.00

\* Prices subject to change without notice.

## IF YOU NEED HELP

If you have any questions or if you need any parts not listed, please call toll-free:

**1-800-345-4109**

or visit our Internet website, [www.gracobaby.com](http://www.gracobaby.com).

Return the form below with payment to:

**GRACO CHILDREN'S PRODUCTS INC.  
CUSTOMER SERVICE DEPARTMENT  
P.O. BOX 100, MAIN STREET  
ELVERSON, PA 19520**

<b>Model Number</b>	<b>SHIP TO:</b>
(Must be filled in)	Name _____
<input type="checkbox"/> Seat	Address _____
<input type="checkbox"/> Seat back	City, State, Zip _____
<input type="checkbox"/> Caster	( ) _____
<input type="checkbox"/> Rear wheel	Telephone _____
<input type="checkbox"/> Parking stand	
<input type="checkbox"/> Skid strip	
<input type="checkbox"/> Pin	
<input type="checkbox"/> Playtray	<input type="checkbox"/> Check enclosed
<input type="checkbox"/> Mounting hooks	(payable to Graco Children's Products Inc.)
<input type="checkbox"/> Spoiler	<input type="checkbox"/> Charge to credit card:
	<input type="checkbox"/> Visa
Total: _____	<input type="checkbox"/> MasterCard
Shipping & handling*: _____ \$5.00	<input type="checkbox"/> Discover
6% sales tax (PA only): _____	Account #: _____
Total amount due: _____	Expiration date: _____
*Outside the continental U.S., please call for shipping cost.	Signature: _____